



DISTRIBUIDORES FI
IF SPLITTERS
REPARTITEURS BIS



SERIE 906 SERIES

CÓDIGO-CODE-CODE		9060036	9060037	9060041	9060042	
MODELO-MODEL-MODELE		FI-243	FI-473	FI-253	FI-483	
Conector Connector Connecteur		F				
Salidas Outputs Sorties		2	4	2	4	
Rango de frecuencia Frequency range Gamme de fréquences	MHz	5 - 2400				
Atenuación de distribución Splitter loss Atténuation de répartition ①	dB TOL $\pm 1,0$	5-13 MHz 13-47 MHz 47-862 MHz 950-2150 MHz 2150-2400 MHz	5,0-5,0 5,0-4,0 4,0-4,0 4,0-5,5 5,5-6,0	10,0-10,0 10,0-9,0 9,0-9,0 9,0-10,5 10,5-12,0	5,0-5,0 5,0-4,5 4,5-4,0 4,0-4,0 4,0-4,5	14,0-9,5 9,5-9,5 9,5-8,0 8,0-10,5 10,5-12,5
Planitud en banda Flatness response Ondulation dans la bande	dB	$\pm 0,3$			$\pm 0,5$	
Desacoplo Isolation Découplage ②	dB	5-13 MHz 13-47 MHz 47-862 MHz 950-2150 MHz 2150-2400 MHz	> 20 > 20 > 19 > 19 > 20	> 26 > 26 > 16 > 16 > 14	> 9 > 13 > 13 > 15 > 16	> 14 > 14 > 12 > 8 > 6
Pérdidas de retorno Return losses Pertes de retour	dB	5-13 MHz 13-47 MHz 47-862 MHz 950-2150 MHz 2150-2400 MHz	> 14 > 14 > 16 > 13 > 19	> 18 > 18 > 12 > 17 > 14	> 13 > 14 > 15 > 13 > 16	- > 11 > 11 > 11 > 9

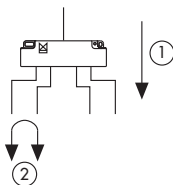

Data published in compliance with the definitions and measurement methods of the following standards: EN 50083-3, EN 50083-4 and EN 50083-5

CÓDIGO-CODE-CODE		9060055	9060078	9060056	9060079	
MODELO-MODEL-MODELE		FI-244	FI-374	FI-474	FI-594	
Conector Connector Connecteur		F				
Salidas Outputs Sorties		2	3	4	5	
Rango de frecuencia Frequency range Gamme de fréquences	MHz	5 - 2400				
Atenuación de distribución Splitter loss Atténuation de répartition ①	dB TOL ±1,0	5-13 MHz 13-47 MHz 47-862 MHz 950-2150 MHz 2150-2400 MHz	4,5-4,5 4,5-4,0 4,0-4,5 4,5-5,5 5,5-6,5	7,5-7,5 7,5-7,5 7,5-9,0 9,0-10,5 10,5-10,5	10,0-10,0 10,0-8,5 8,5-9,0 9,0-11,0 11,0-13,0	11,0-11,0 11,0-11,5 11,5-13,0 13,0-15,0 15,0-15,0
Planitud en banda Flatness response Ondulation dans la bande	dB	± 0,3				
Desacoplo Isolation Découplage ②	dB	5-13 MHz 13-47 MHz 47-862 MHz 950-2150 MHz 2150-2400 MHz	> 18 > 18 > 20 > 18 > 18	> 20 > 20 > 21 > 23 > 21	> 26 > 26 > 15 > 16 > 15	> 20 > 20 > 22 > 24 > 23
Pérdidas de retorno Return losses Pertes de retour	dB	5-13 MHz 13-47 MHz 47-862 MHz 950-2150 MHz 2150-2400 MHz	> 17 > 17 > 15 > 12 > 15	> 16 > 16 > 11 > 11 > 11	> 19 > 19 > 13 > 16 > 10	> 15 > 15 > 11 > 11 > 12
Paso de corriente DC path Passage d'alimentation	V_{\sim} mA		34 (max) 300 (max) 22KHz/DiSEqC	30 (max) 400 (max) 22KHz/DiSEqC	34 (max) 300 (max) 22KHz/DiSEqC	30 (max) 400 (max) 22KHz/DiSEqC

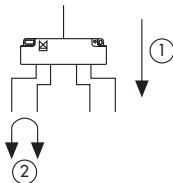

Los distribuidores incluyen diodos de protección para los receptores de satélite.
 Splitters include protection diodes for satellite signal receivers.
 Les distributeurs comportent des diodes de protection pour les terminaux satellites.

CÓDIGO-CODE-CODE		9060057	9060058
MODELO-MODEL-MODELE		FI-254	FI-484
Conector Connector Connecteur		F	
Salidas Outputs Sorties		2	4
Rango de frecuencia Frequency range Gamme de fréquences	MHz	5 - 2400	
Atenuación de distribución Splitter loss Atténuation de répartition ①	dB TOL ±1,0	5-13 MHz 13-47 MHz 47-862 MHz 950-2150 MHz 2150-2400 MHz	5,0-5,0 5,0-4,5 4,5-4,0 4,0-4,0 4,0-5,0
Planitud en banda Flatness response Ondulation dans la bande	dB	± 0,3	± 0,5
Desacoplo Isolation Découplage ②	dB	5-13 MHz 13-47 MHz 47-862 MHz 950-2150 MHz 2150-2400 MHz	> 9 > 12 > 13 > 15 > 14
Pérdidas de retorno Return losses Pertes de retour	dB	5-13 MHz 13-47 MHz 47-862 MHz 950-2150 MHz 2150-2400 MHz	> 14 > 14 > 12 > 8 > 6
Paso de corriente DC path Passage d'alimentation	V_{\sim} mA	34 (max) 300 (max) 22KHz / DiSEqC	

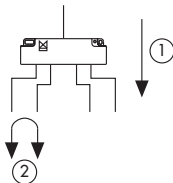

Los distribuidores incluyen diodos de protección para los receptores de satélite.
 Splitters include protection diodes for satellite signal receivers.
 Les distributeurs comportent des diodes de protection pour les terminaux satellites.

CÓMO PREPARAR LOS CONECTORES F

HOW TO PREPARE THE F CONNECTORS

COMMENT PREPARER LES CONNECTEURS F

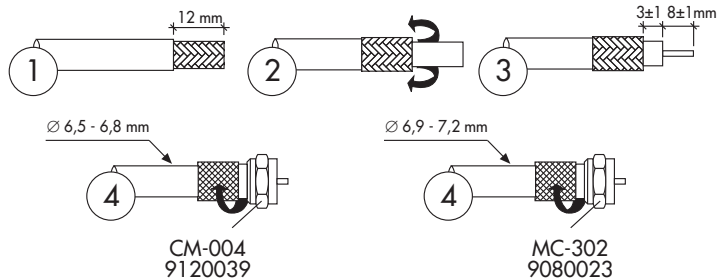

Los conectores se venden por separado.
The connectors are sold separately.
Les connecteurs a vendre séparément.

MONTAJE EN LA PARED Y CONEXIÓN A LA TOMA DE TIERRA

WALL-MOUNTING AND CONNECTION TO EARTH

MONTAGE SUR LE MUR ET CONEXION À LA PRISE DE TERRE

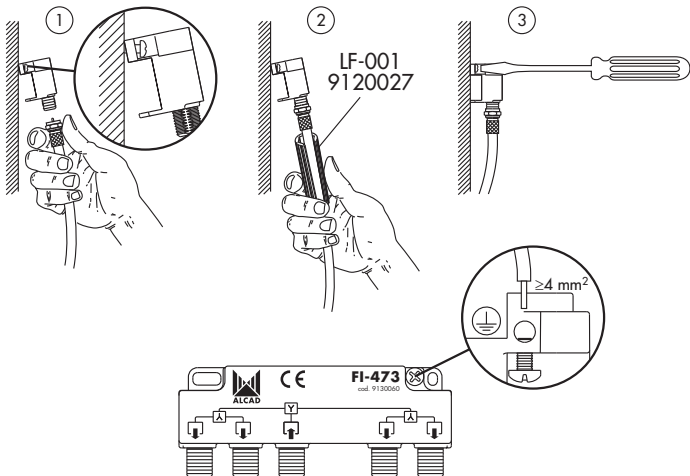

MONTAJE EN INTEMPERIE
OUTDOORS MOUNTING
MONTAGE EXTERNE

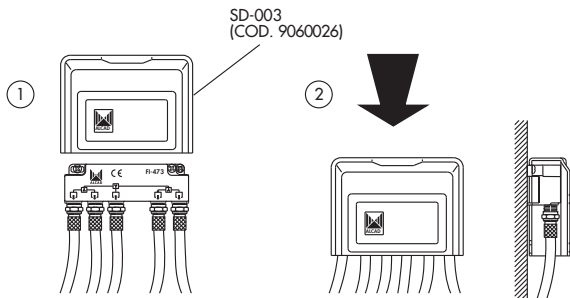

INSTALACIÓN INDIVIDUAL
INDIVIDUAL INSTALLATION
INSTALLATION INDIVIDUELLE

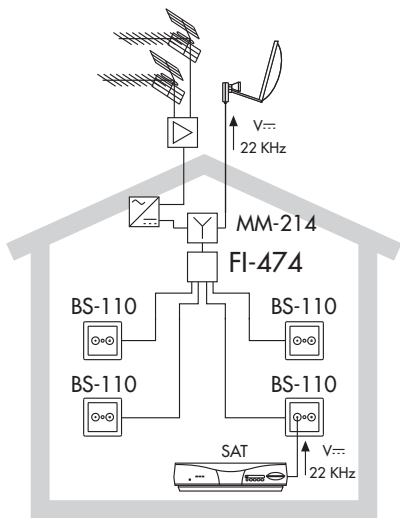

INSTALACIÓN COLECTIVA
SMATV COLLECTIVE INSTALLATIONS
INSTALLATION COLLECTIVE SMATV

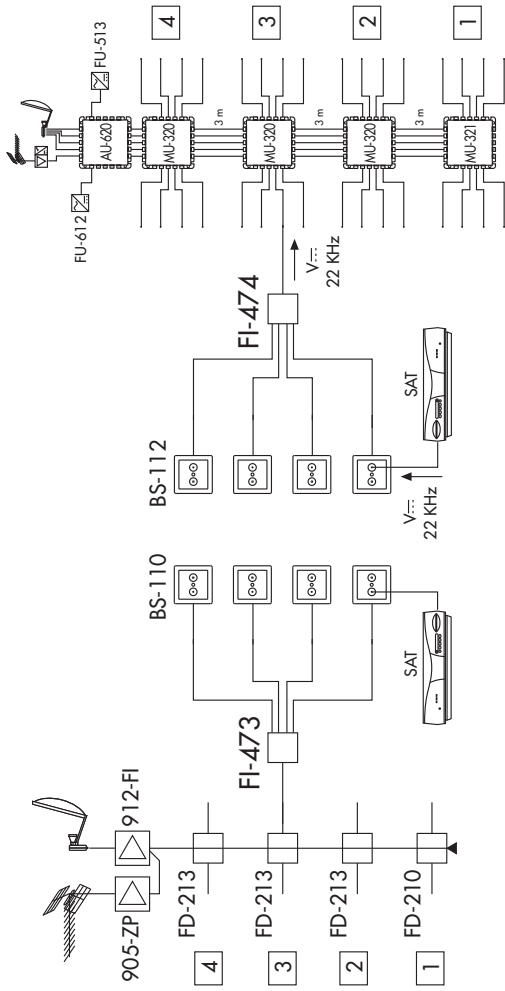



DECLARATION OF CONFORMITY

according to EN ISO/IEC 17050-1:2004

Manufacturer's Name: ALCAD, S.L.
Manufacturer's Address: Pol. Ind. Arreche-Ugalde, 1
Apdo. 455, 20305 IRÚN (Guipúzcoa), SPAIN

declares that the product

Model Number(s): FI-243, FI-473, FI-253, FI-483, FI-244,
FI-374, FI-474, FI-594, FI-254, FI-484

Product Description: IF SPLITTERS

Product Option(s): INCLUDING ALL OPTIONS

is in conformity with:

Safety: EN 50083-1:1993

EMC: EN 50083-2:2001

The product herewith complies with the requirements of the Low Voltage Directive 2006/95/EC and the EMC Directive 2004/108/EC.

Supplementary Information: To comply with these directives, do not use the products without covers and operate the system as specified.



Irún(SPAIN), 10 Nov 2008



Francisco Navarro
General Manager

Especificaciones sujetas a modificación sin previo aviso
Specifications subject to modifications without prior notice
Les spécifications sont soumises à de possible modifications sans avis préalable



ALCAD, S.L.
Tel. 943 63 96 60
Fax 943 63 92 66
Int. Tel. +34 - 943 63 96 60
info@alcad.net
Apdo. 455 - Pol. Ind. Arreche-Ugalde, 1
20305 IRUN - Spain

www.alcad.net

FRANCE - Hendaye
Tel. 00 34 - 943 63 96 60

GERMANY - Munich
Tel. 089 55 26 480

CZECH REPUBLIC - Ostrovačice
Tel. 546 427 059

UNITED ARAB EMIRATES - Dubai
Tel. 971 4 887 19 50

TURKEY - Istanbul
Tel. 212 295 97 00



ISO 9001

